

Standaard details
 Gemeente Lopik
 Detail 1
 Onderwaterbeschoeiing

VERSIE	DATUM	GETEKEND	GECONTROLEERD
D.01	07-12-2021	R. Khatri	P. Verweij



Postbus 50
 3410 CB LOPIK
 Raadhuisplein 1
 Tel: (0348) 55 99 55
 Fax: (0348) 55 15 88
 E-mailadres:
 gemeente@lopik.nl

SCHAAL	1:20
FORMAAT	A4
STATUS	Definitief
NUMMER	2021-0089
BLAD	1 van 38

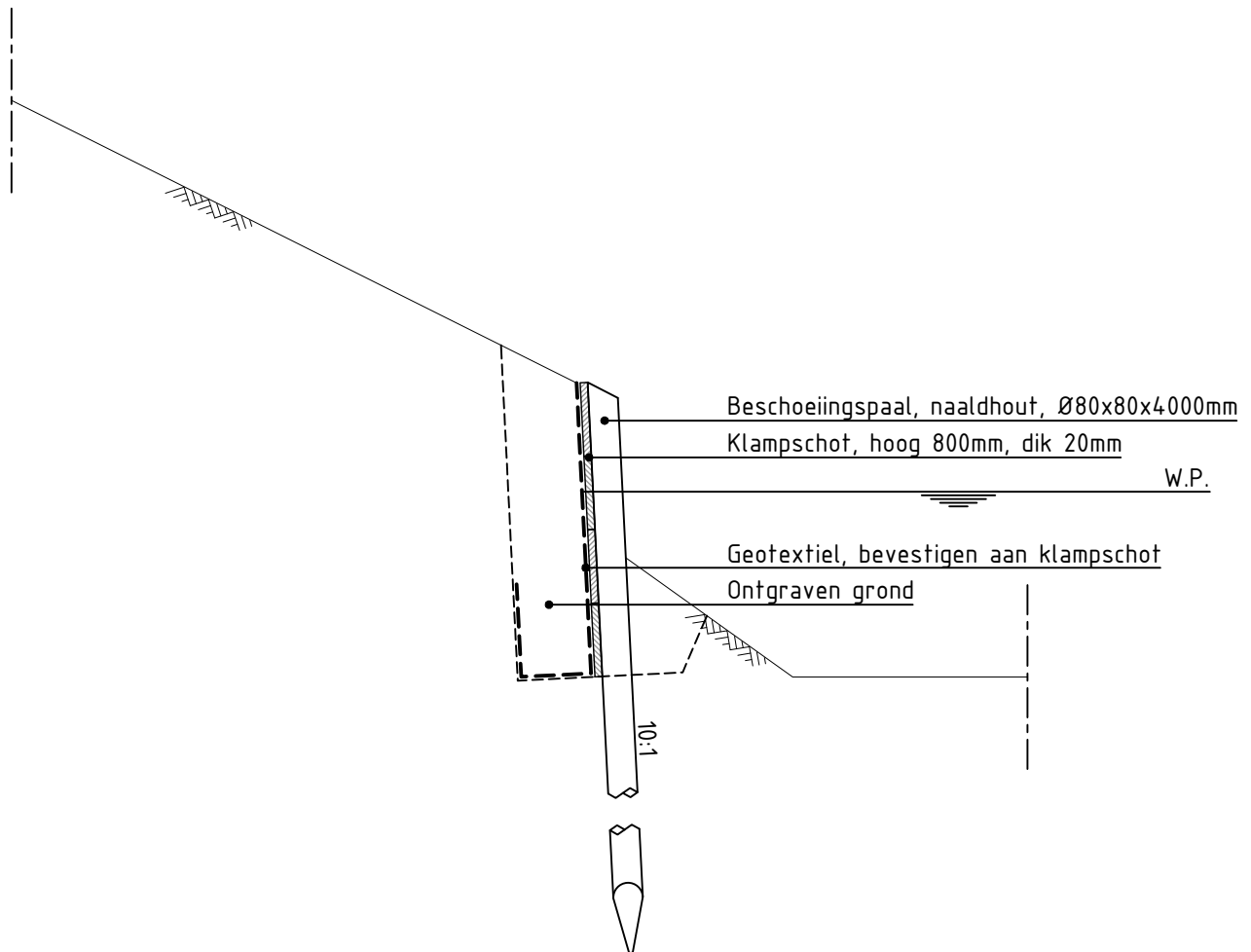

Standaard details
 Gemeente Lopik
 Detail 2
 Bovenwaterbeschoeiing

VERSIE	DATUM	GETEKEND	GECONTROLEERD
D.01	07-12-2021	R. Khatri	P. Verweij



Postbus 50
 3410 CB LOPIK
 Raadhuisplein 1
 Tel: (0348) 55 99 55
 Fax: (0348) 55 15 88
 E-mailadres:
 gemeente@lopiik.nl

SCHAAL	1:20
FORMAAT	A4
STATUS	Definitief
NUMMER	2021-0089
BLAD	2 van 38

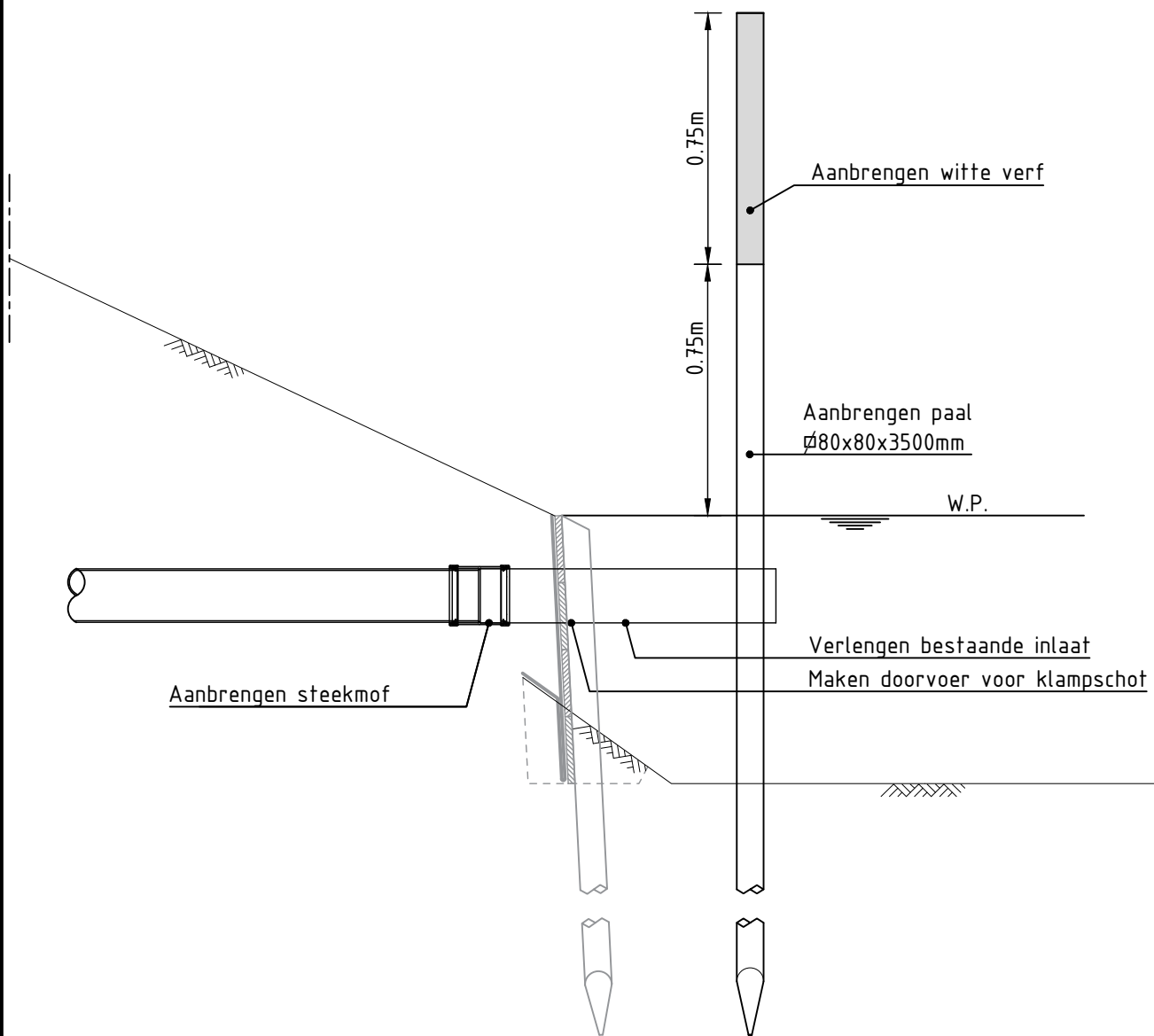

Standaard details
 Gemeente Lopik
 Detail 3
 Maaibeschermin inlaten beschoeiing

VERSIE	DATUM	GETEKEND	GECONTROLEERD
D.01	07-12-2021	R. Khatri	P. Verweij



Postbus 50
 3410 CB LOPIK
 Raadhuisplein 1
 Tel: (0348) 55 99 55
 Fax: (0348) 55 15 88
 E-mailadres:
 gemeente@lopiik.nl

SCHAAL	1:20
FORMAAT	A4
STATUS	Definitief
NUMMER	2021-0089
BLAD	3 van 38

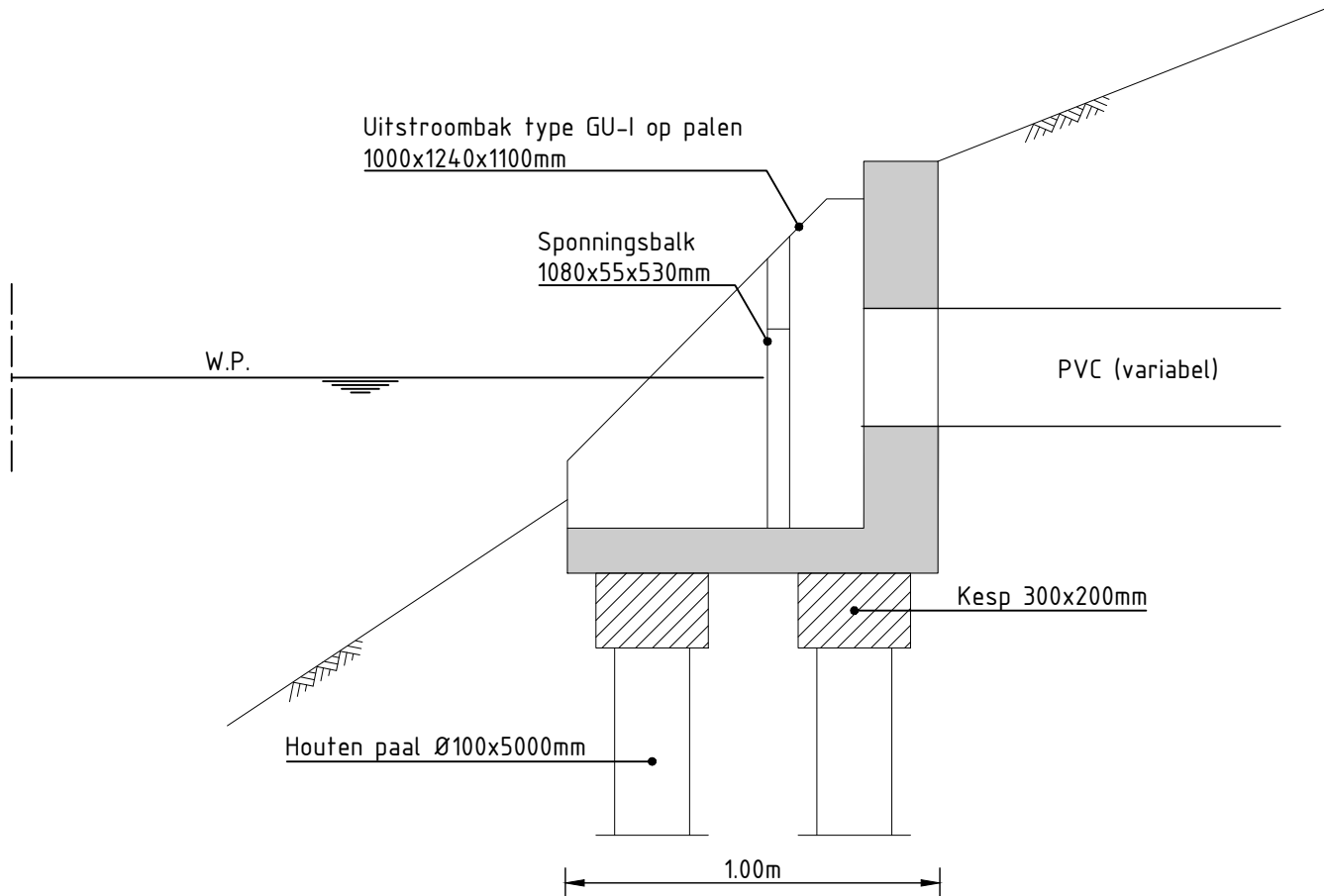

Standaard details

Gemeente Lopik

Detail 4

Uitstroombak

VERSIE	DATUM	GETEKEND	GECONTROLEERD
D.01	07-12-2021	R. Khatri	P. Verweij



**GEMEENTE
LOPIK**

Postbus 50
3410 CB LOPIK

Raadhuisplein 1
Tel: (0348) 55 99 55
Fax: (0348) 55 15 88
E-mailadres:
gemeente@lopik.nl

SCHAAL	1:20
FORMAAT	A4
STATUS	Definitief
NUMMER	2021-0089
BLAD	4 van 38

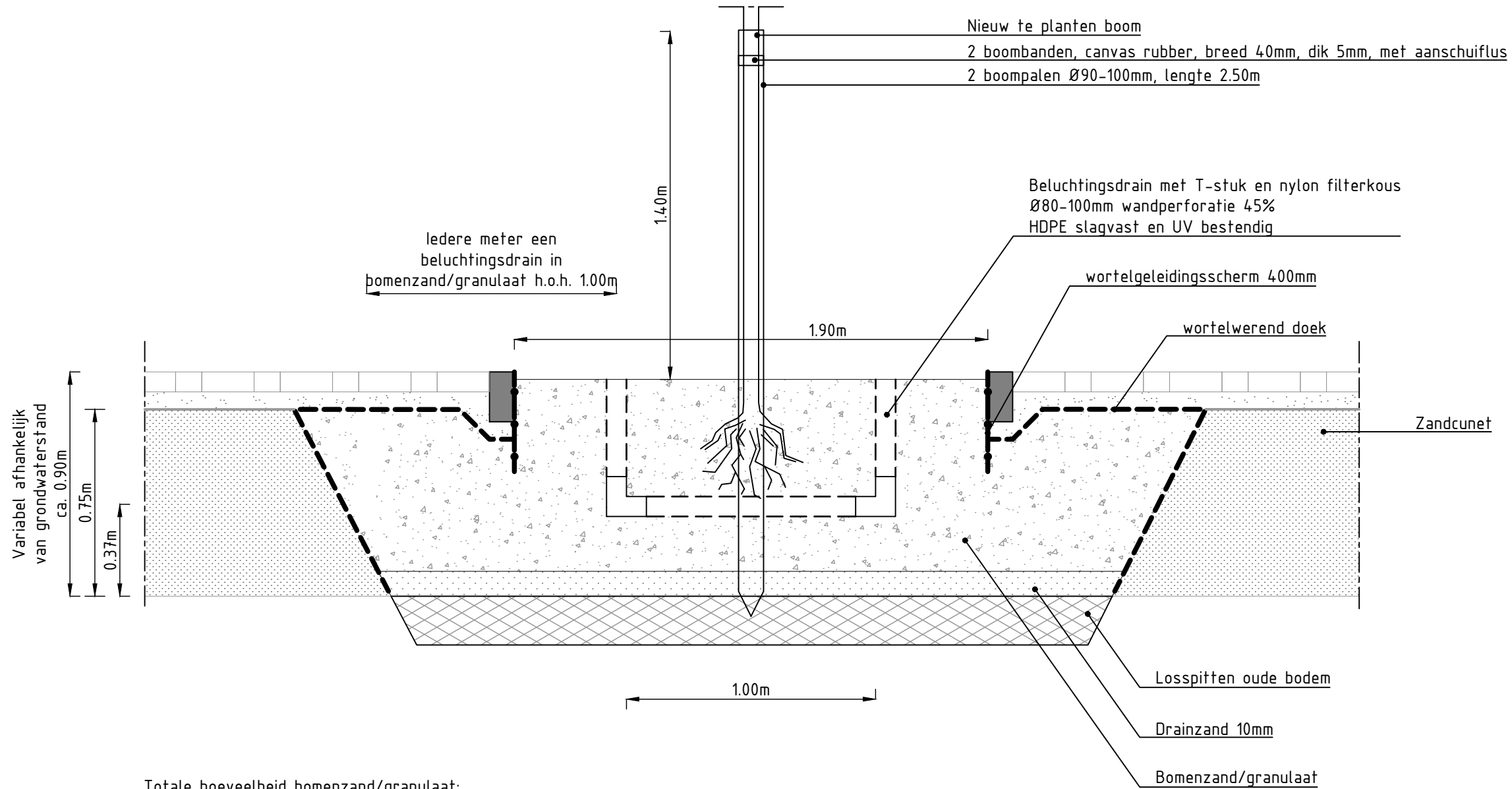

Totale hoeveelheid bomenzand/granulaat:
 - Programma van eisen, inrichting openbare ruimte

Standaard details
 Gemeente Lopik
 Detail 5
 Boomplantvak in verharding

VERSIE	DATUM	GETEKEND	GECONTROLEERD
D.01	07-12-2021	R. Khatri	P. Verweij



Postbus 50
 3410 CB LOPIK

Raadhuisplein 1
 Tel: (0348) 55 99 55
 Fax: (0348) 55 15 88
 E-mailadres:
 gemeente@lopiik.nl

SCHAAL	1:50
FORMAAT	A3
STATUS	Definitief
NUMMER	2021-0089
BLAD	5 van 38

Straatkolk, beton
 Type STR 9742, Tweedelig
 450x300mm

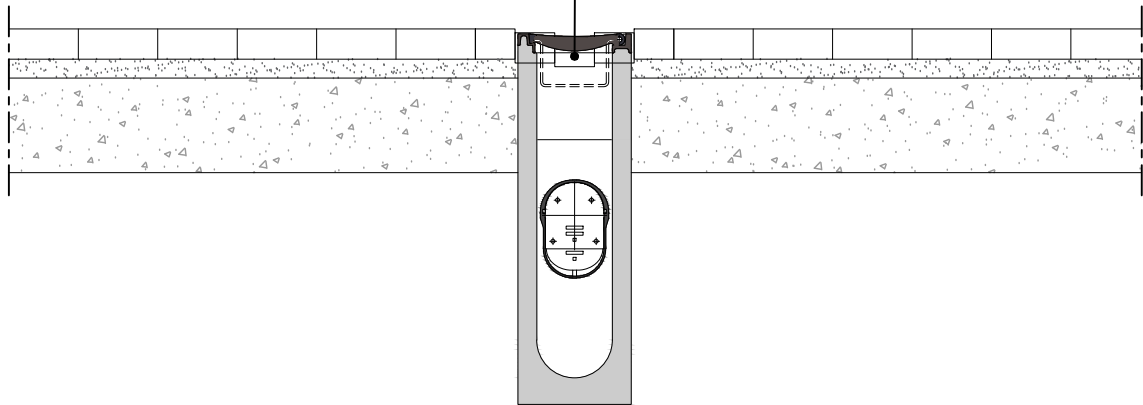

Standaard details
 Gemeente Lopik
 Detail 6
 Hemelwaterafvoer t.p.v. molgoot

VERSIE	DATUM	GETEKEND	GECONTROLEERD
D.01	07-12-2021	R. Khatri	P. Verweij



Postbus 50
 3410 CB LOPIK
 Raadhuisplein 1
 Tel: (0348) 55 99 55
 Fax: (0348) 55 15 88
 E-mailadres:
 gemeente@lopiik.nl

SCHAAL	1:20
FORMAAT	A4
STATUS	Definitief
NUMMER	2021-0089
BLAD	6 van 38

Trottoirkolk, beton
 Type TRK 4718, Eendelig
 4,50x300mm

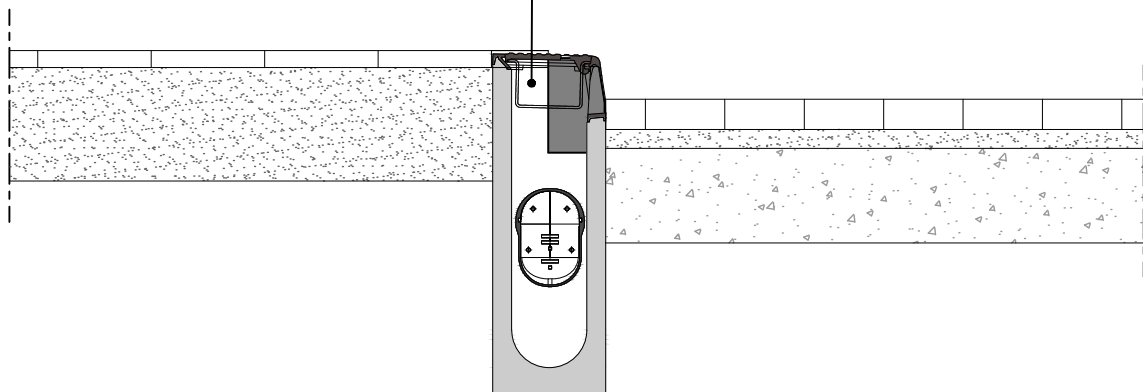

Standaard details

Gemeente Lopik

Detail 7

Hemelwaterafvoer t.p.v. trottoirband

VERSIE	DATUM	GETEKEND	GECONTROLEERD
D.01	07-12-2021	R. Khatri	P. Verweij



**GEMEENTE
LOPIK**

Postbus 50
 3410 CB LOPIK

Raadhuisplein 1
 Tel: (0348) 55 99 55
 Fax: (0348) 55 15 88
 E-mailadres:
 gemeente@lopiik.nl

SCHAAL	1:20
FORMAAT	A4
STATUS	Definitief
NUMMER	2021-0089
BLAD	7 van 38

Trottoirkolk, beton
 Type TRK 2020, Eindelijk
 450x450mm

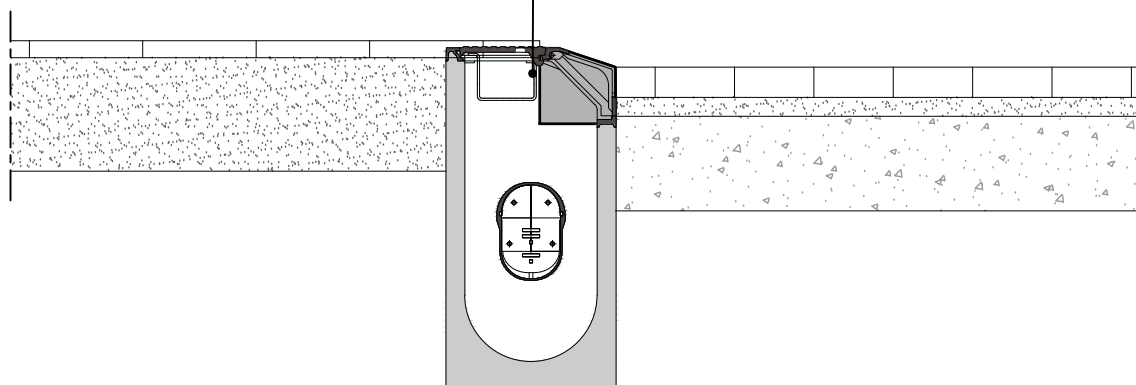

Standaard details

Gemeente Lopik

Detail 8

Hemelwaterafvoer t.p.v. geleideband

VERSIE	DATUM	GETEKEND	GECONTROLEERD
D.01	07-12-2021	R. Khatri	P. Verweij



Postbus 50
 3410 CB LOPIK

Raadhuisplein 1
 Tel: (0348) 55 99 55
 Fax: (0348) 55 15 88
 E-mailadres:
 gemeente@lopiik.nl

SCHAAL	1:20
FORMAAT	A4
STATUS	Definitief
NUMMER	2021-0089
BLAD	8 van 38

RWS-kolk, beton
 Type RWS450x375, Tweedelig
 450x375mm

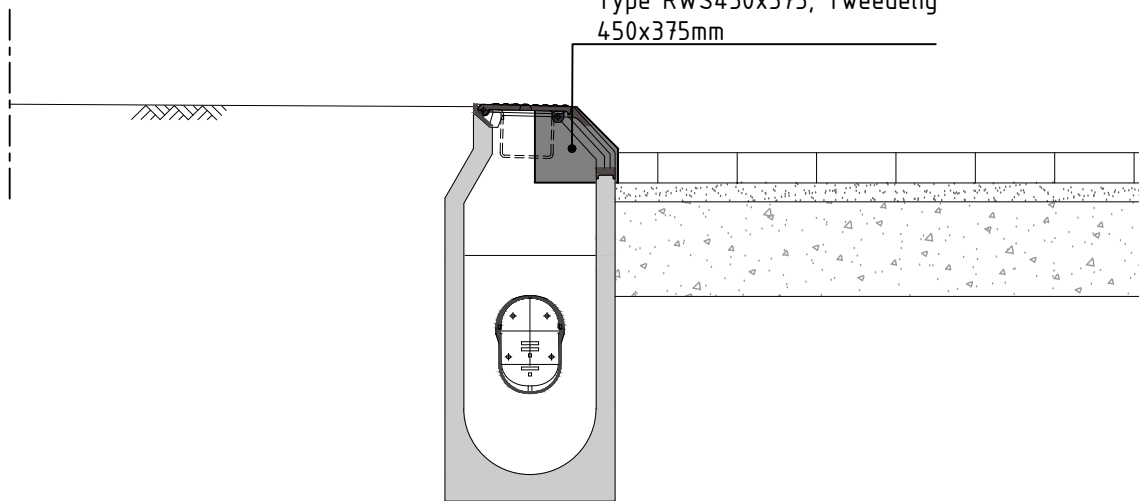

Standaard details
 Gemeente Lopik
 Detail 9
 Hemelwaterafvoer t.p.v. RWS band

VERSIE	DATUM	GETEKEND	GECONTROLEERD
D.01	07-12-2021	R. Khatri	P. Verweij



Postbus 50
 3410 CB LOPIK
 Raadhuisplein 1
 Tel: (0348) 55 99 55
 Fax: (0348) 55 15 88
 E-mailadres:
 gemeente@lopiik.nl

SCHAAL	1:20
FORMAAT	A4
STATUS	Definitief
NUMMER	2021-0089
BLAD	9 van 38

Tegelpadkolk klasse Y, PVC met waaierkop
 Type STR 9742, Tweedelig
 450x300mm

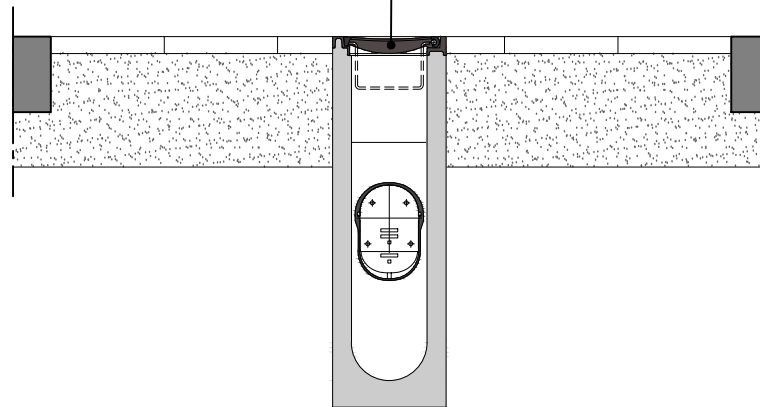

Standaard details

Gemeente Lopik

Detail 10

Hemelwaterafvoer t.p.v. tegelpad

VERSIE	DATUM	GETEKEND	GECONTROLEERD
D.01	07-12-2021	R. Khatri	P. Verweij



**GEMEENTE
LOPIK**

Postbus 50
 3410 CB LOPIK

Raadhuisplein 1
 Tel: (0348) 55 99 55
 Fax: (0348) 55 15 88
 E-mailadres:
 gemeente@lopiik.nl

SCHAAL	1:20
FORMAAT	A4
STATUS	Definitief
NUMMER	2021-0089
BLAD	10 van 38

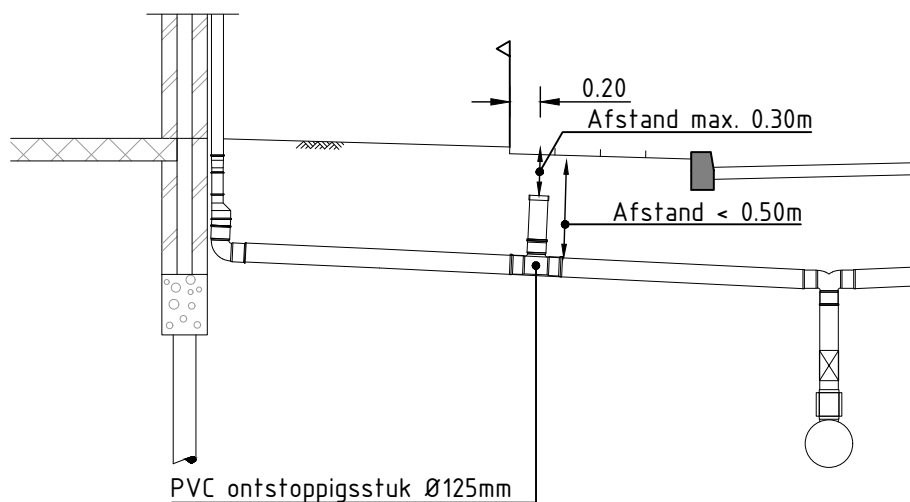

Standaard details

Gemeente Lopik

Detail 11

Ontstoppingsstuk huisaansluiting tot 0.50m

VERSIE	DATUM	GETEKEND	GECONTROLEERD
D.01	07-12-2021	R. Khatri	P. Verweij



Postbus 50
3410 CB LOPIK

Raadhuisplein 1
Tel: (0348) 55 99 55
Fax: (0348) 55 15 88
E-mailadres:
gemeente@lopiik.nl

SCHAAL	1:50
FORMAAT	A4
STATUS	Definitief
NUMMER	2021-0089
BLAD	11 van 38

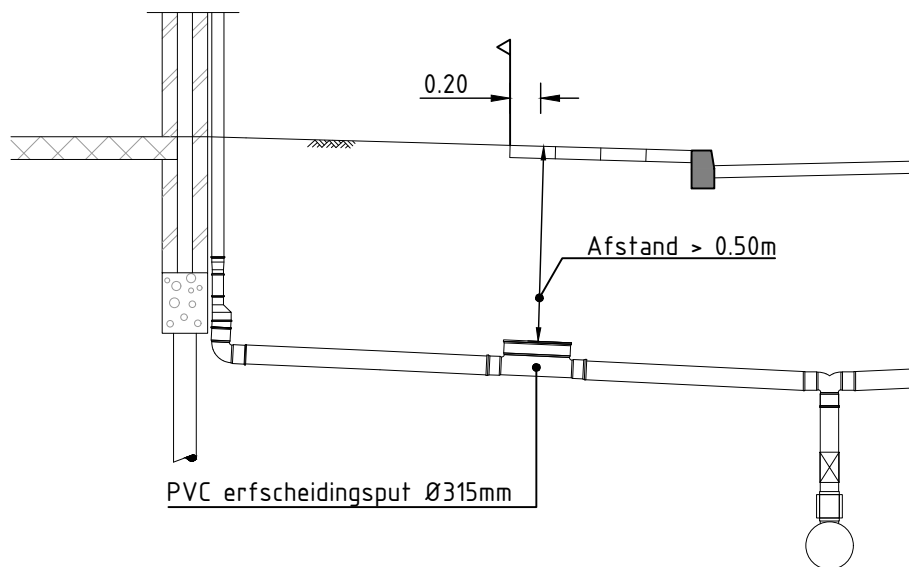

Standaard details

Gemeente Lopik

Detail 12

Ontstoppingsstuk huisaansluiting vanaf 0.50m

VERSIE	DATUM	GETEKEND	GECONTROLEERD
D.01	07-12-2021	R. Khatri	P. Verweij



Postbus 50
3410 CB LOPIK

Raadhuisplein 1
Tel: (0348) 55 99 55
Fax: (0348) 55 15 88
E-mailadres:
gemeente@lopiik.nl

**GEMEENTE
LOPIK**

SCHAAL	1:50
FORMAAT	A4
STATUS	Definitief
NUMMER	2021-0089
BLAD	12 van 38

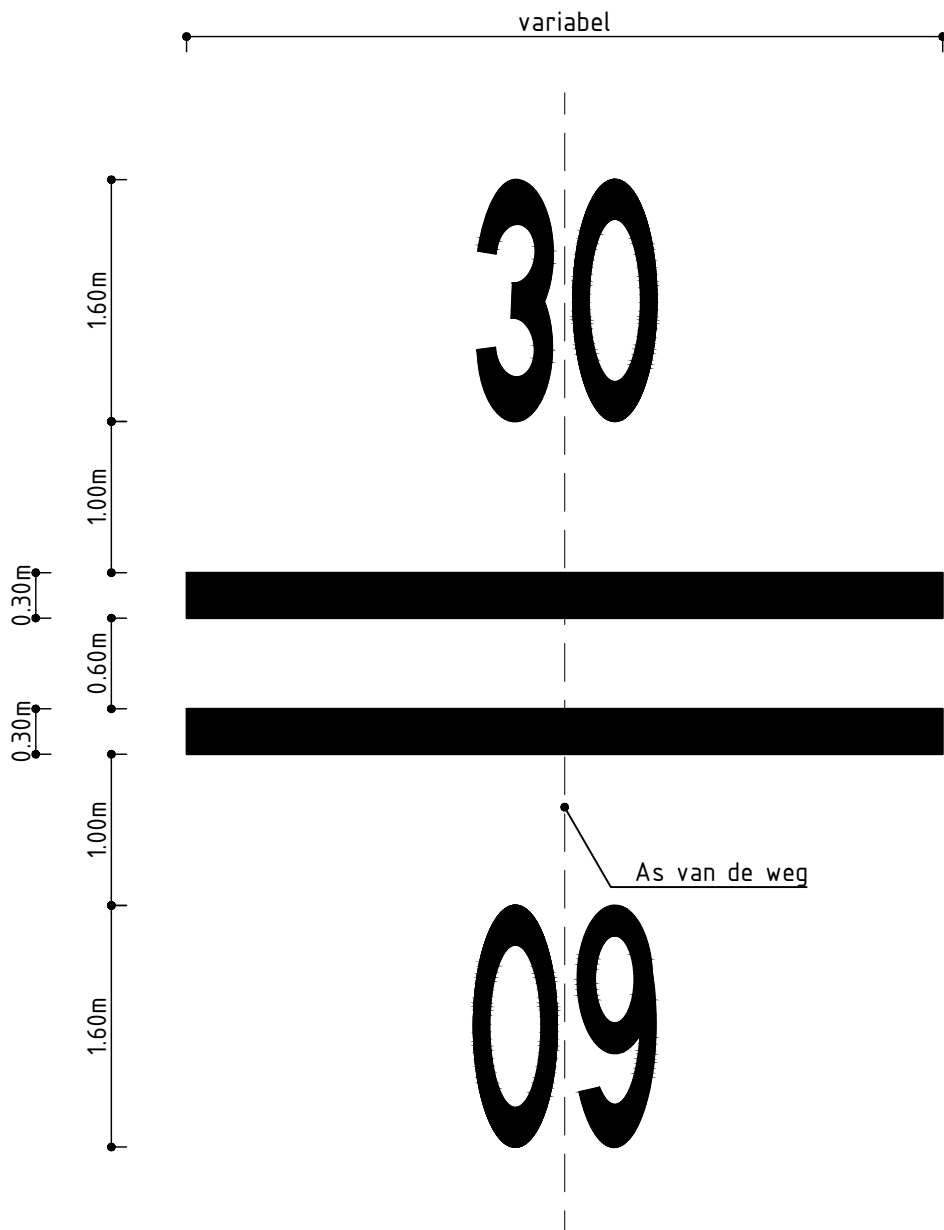

Standaard details

Gemeente Lopik

Detail 13

Snelheidsovergang 30km/u en 60 km/u

VERSIE	DATUM	GETEKEND	GECONTROLEERD
D.01	07-12-2021	R. Khatri	P. Verweij



**GEMEENTE
LOPIK**

Postbus 50
3410 CB LOPIK

Raadhuisplein 1
Tel: (0348) 55 99 55
Fax: (0348) 55 15 88
E-mailadres:
gemeente@lopiik.nl

SCHAAL	1:50
FORMAAT	A4
STATUS	Definitief
NUMMER	2021-0089
BLAD	13 van 38

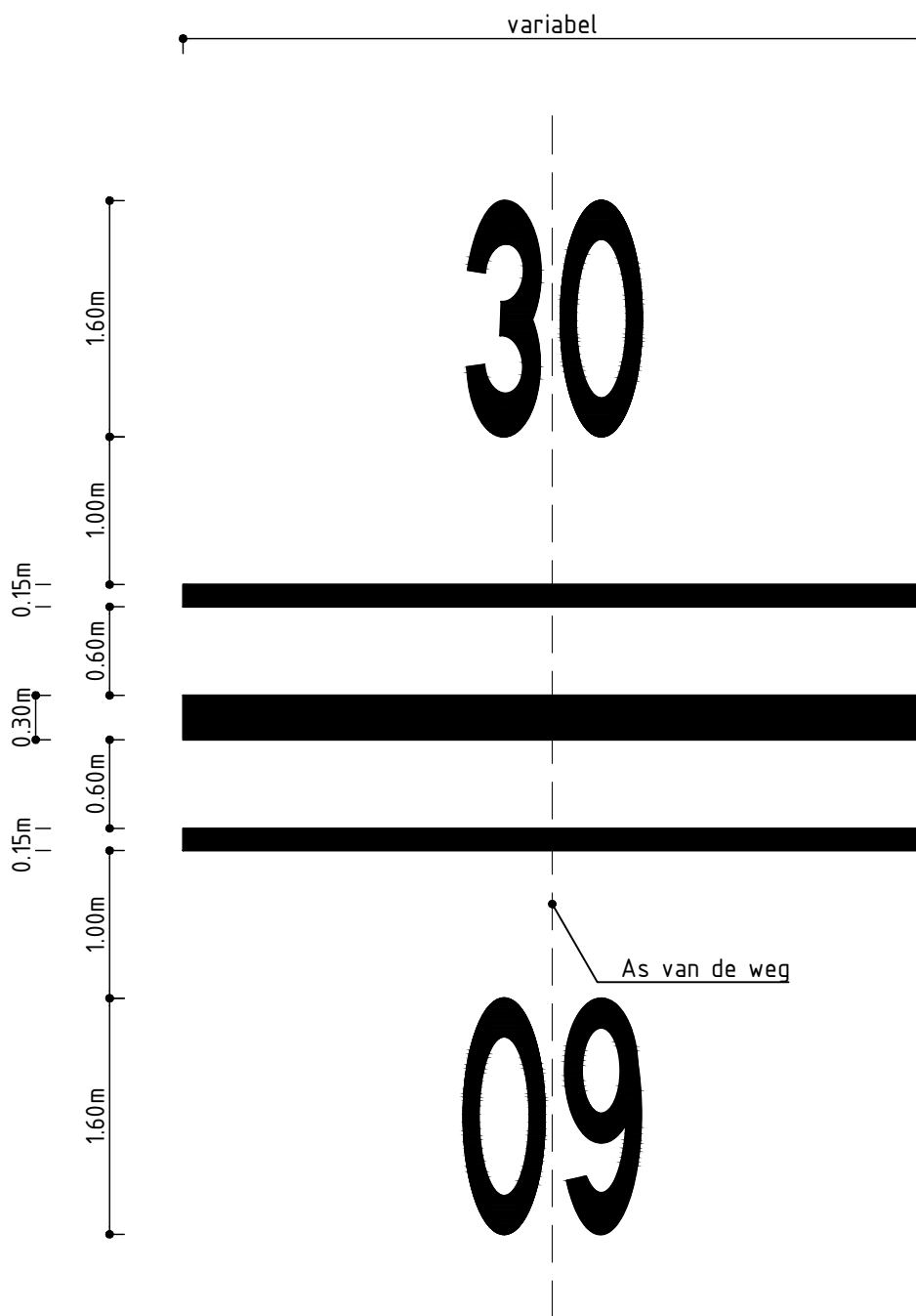

Standaard details

Gemeente Lopik

Detail 14

Komgrens 30 km/u en 60km/u

VERSIE	DATUM	GETEKEND	GECONTROLEERD
D.01	07-12-2021	R. Khatri	P. Verweij



**GEMEENTE
LOPIK**

Postbus 50
3410 CB LOPIK

Raadhuisplein 1
Tel: (0348) 55 99 55
Fax: (0348) 55 15 88
E-mailadres:
gemeente@lopiik.nl

SCHAAL	1:50
FORMAAT	A4
STATUS	Definitief
NUMMER	2021-0089
BLAD	14 van 38

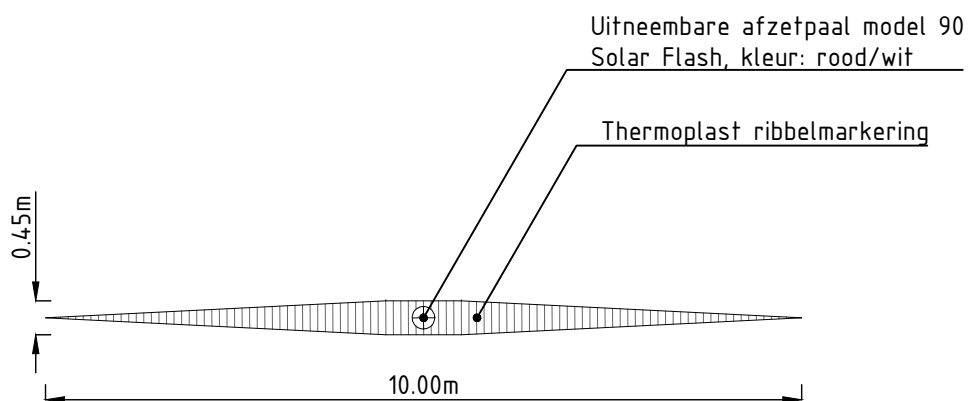

Standaard details

Gemeente Lopik

Detail 15

Paal fietspad met inleidende markering

VERSIE	DATUM	GETEKEND	GECONTROLEERD
D.01	07-12-2021	R. Khatri	P. Verweij



Postbus 50
3410 CB LOPIK

Raadhuisplein 1
Tel: (0348) 55 99 55
Fax: (0348) 55 15 88
E-mailadres:
gemeente@lopik.nl

SCHAAL	1:100
FORMAAT	A4
STATUS	Definitief
NUMMER	2021-0089
BLAD	15 van 38

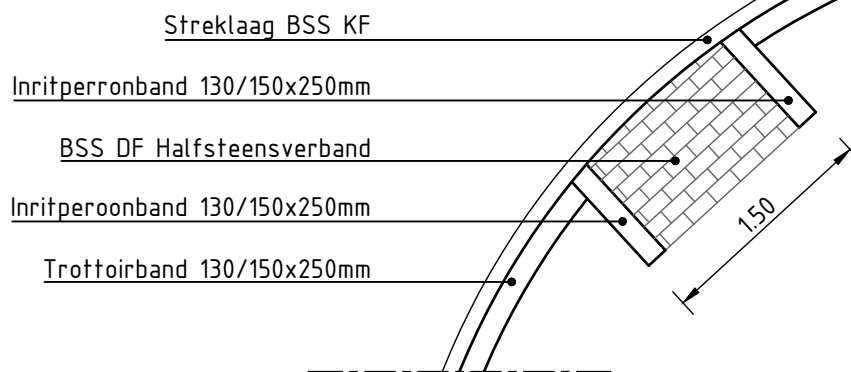

Standaard details
 Gemeente Lopik
 Detail 16
 Mindervalide oprit

VERSIE	DATUM	GETEKEND	GECONTROLEERD
D.01	07-12-2021	R. Khatri	P. Verweij



Postbus 50
 3410 CB LOPIK

Raadhuisplein 1
 Tel: (0348) 55 99 55
 Fax: (0348) 55 15 88
 E-mailadres:
 gemeente@lopiik.nl

SCHAAL	1:50
FORMAAT	A4
STATUS	Definitief
NUMMER	2021-0089
BLAD	16 van 38

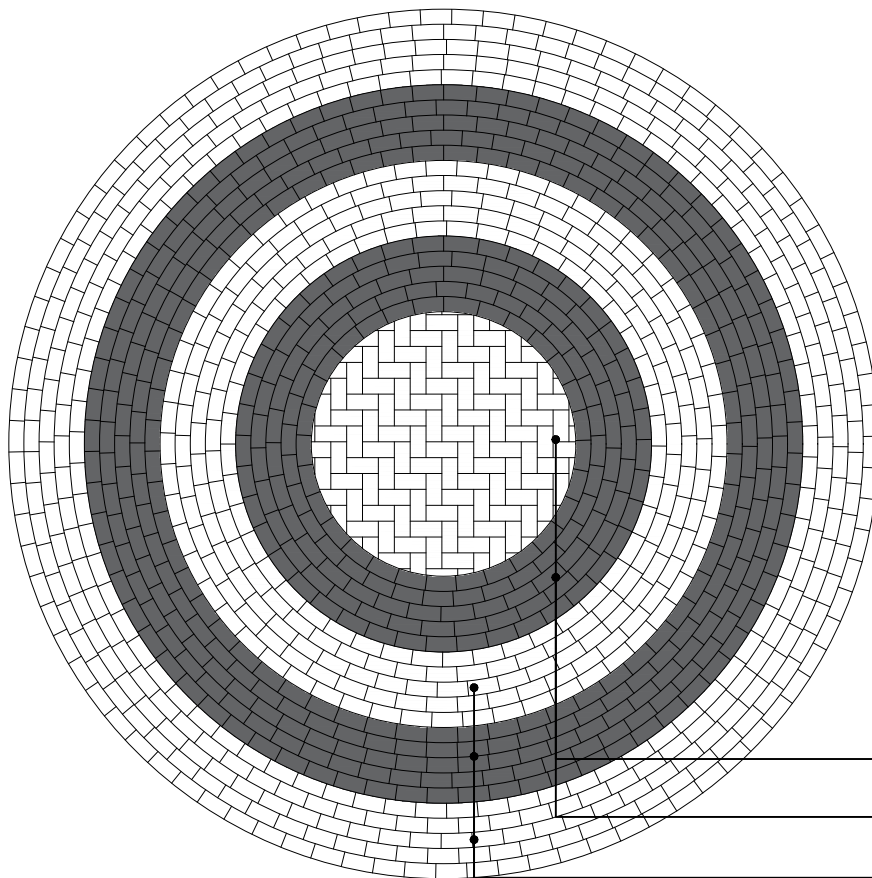

BSS, KF, elleboogverband, wit

BSS, KF, 5 strekken, zwart

BSS, KF, 5 strekken, wit

BSS, KF, 5 strekken, zwart

BSS, KF, 5 strekken, wit

Standaard details

Gemeente Lopik

Detail 17

Cirkel betonstraatstenen in kruispunt

VERSIE	DATUM	GETEKEND	GECONTROLEERD
D.01	07-12-2021	R. Khatri	P. Verweij



Postbus 50
3410 CB LOPIK

Raadhuisplein 1
Tel: (0348) 55 99 55
Fax: (0348) 55 15 88
E-mailadres:
gemeente@lopiik.nl

SCHAAL	1:50
FORMAAT	A4
STATUS	Definitief
NUMMER	2021-0089
BLAD	17 van 38

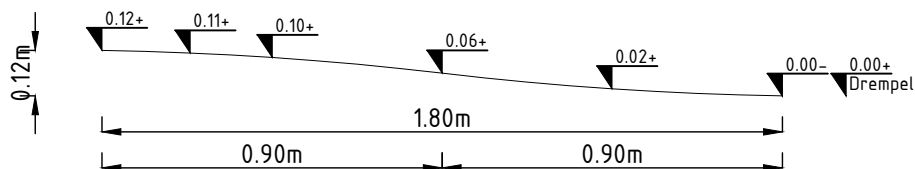
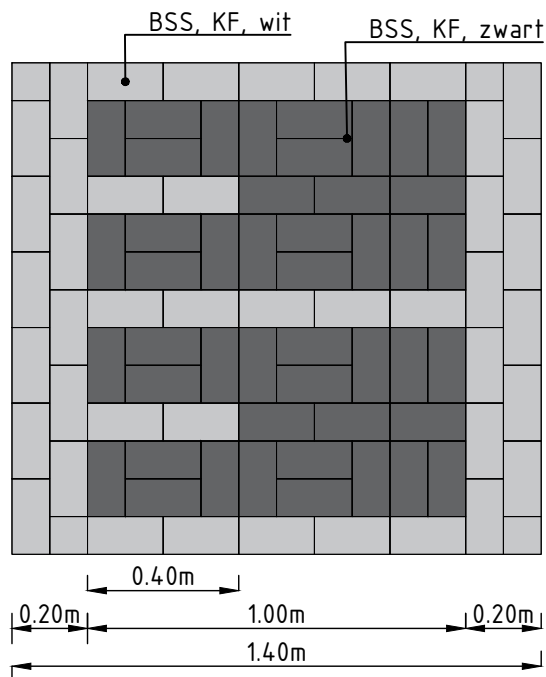

Standaard details

Gemeente Lopik

Detail 18

Drempel 30 km/u

VERSIE	DATUM	GETEKEND	GECONTROLEERD
D.01	07-12-2021	R. Khatri	P. Verweij



Postbus 50
3410 CB LOPIK

Raadhuisplein 1
Tel: (0348) 55 99 55
Fax: (0348) 55 15 88
E-mailadres:
gemeente@lopiik.nl

SCHAAL	1:20
FORMAAT	A4
STATUS	Definitief
NUMMER	2021-0089
BLAD	18 van 38

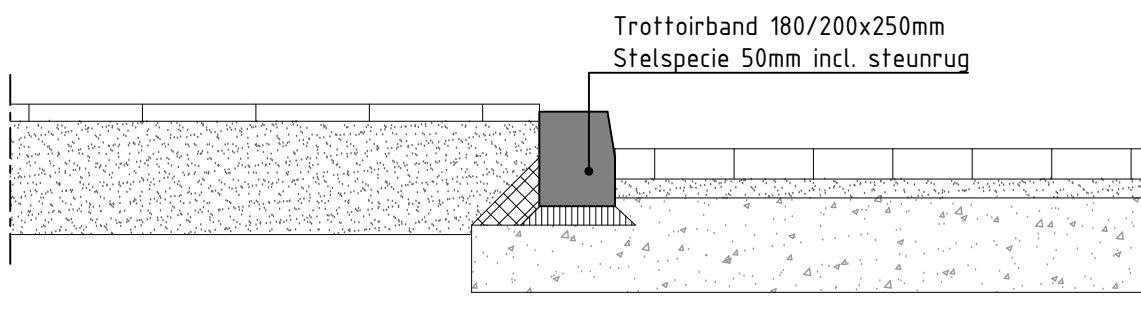

Standaard details

Gemeente Lopik

Detail 19

Trottoirband in specie 180/200x250mm

VERSIE	DATUM	GETEKEND	GECONTROLEERD
D.01	07-12-2021	R. Khatri	P. Verweij



**GEMEENTE
LOPIK**

Postbus 50
3410 CB LOPIK

Raadhuisplein 1
Tel: (0348) 55 99 55
Fax: (0348) 55 15 88
E-mailadres:
gemeente@lopik.nl

SCHAAL	1:20
FORMAAT	A4
STATUS	Definitief
NUMMER	2021-0089
BLAD	19 van 38

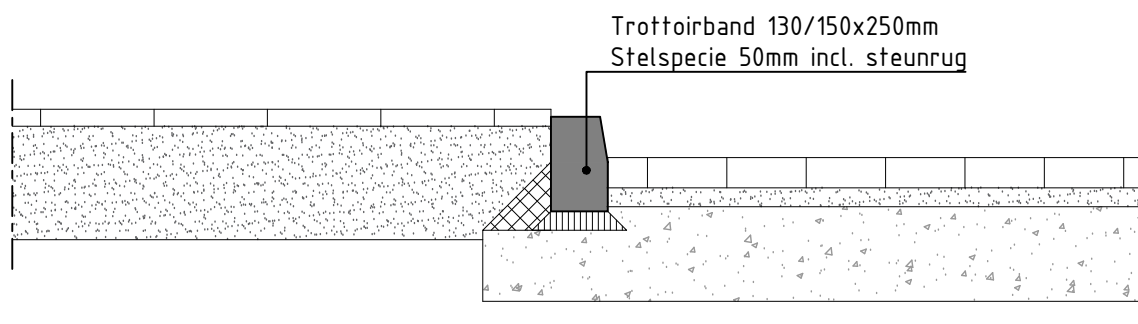

Standaard details

Gemeente Lopik

Detail 20

Trottoirband in specie 130/150x250mm

VERSIE	DATUM	GETEKEND	GECONTROLEERD
D.01	07-12-2021	R. Khatri	P. Verweij



Postbus 50
3410 CB LOPIK

Raadhuisplein 1
Tel: (0348) 55 99 55
Fax: (0348) 55 15 88
E-mailadres:
gemeente@lopik.nl

SCHAAL	1:20
FORMAAT	A4
STATUS	Definitief
NUMMER	2021-0089
BLAD	20 van 38

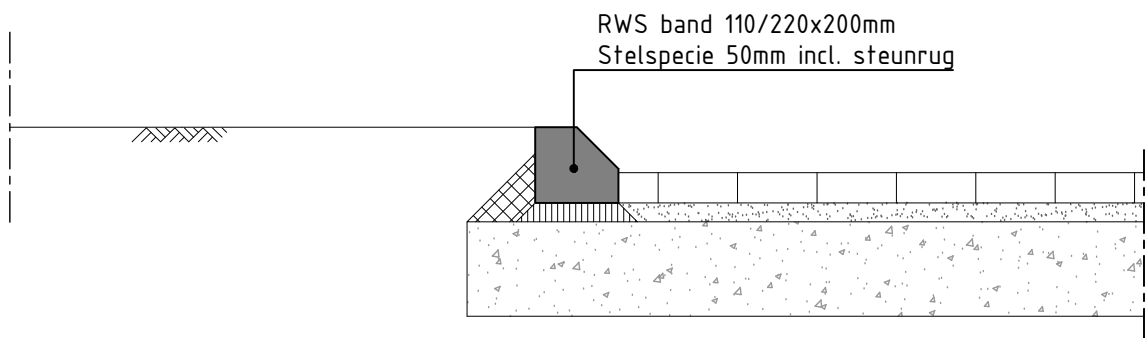

Standaard details

Gemeente Lopik

Detail 21

RWS band in specie 110/220x200mm

VERSIE	DATUM	GETEKEND	GECONTROLEERD
D.01	07-12-2021	R. Khatri	P. Verweij



**GEMEENTE
LOPIK**

Postbus 50
3410 CB LOPIK

Raadhuisplein 1
Tel: (0348) 55 99 55
Fax: (0348) 55 15 88
E-mailadres:
gemeente@lopiik.nl

SCHAAL	1:20
FORMAAT	A4
STATUS	Definitief
NUMMER	2021-0089
BLAD	21 van 38

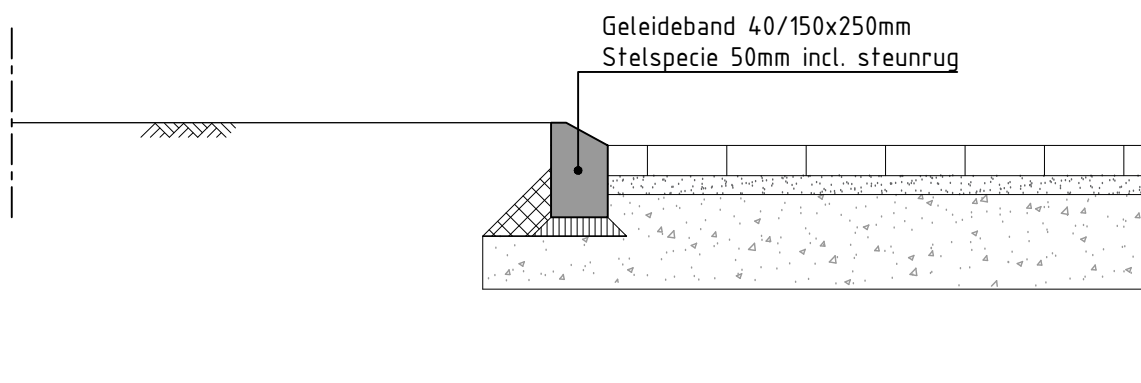

Standaard details

Gemeente Lopik

Detail 22

Geleideband in specie 40/150x250mm

VERSIE	DATUM	GETEKEND	GECONTROLEERD
D.01	07-12-2021	R. Khatri	P. Verweij



**GEMEENTE
LOPIK**

Postbus 50
3410 CB LOPIK

Raadhuisplein 1
Tel: (0348) 55 99 55
Fax: (0348) 55 15 88
E-mailadres:
gemeente@lopiik.nl

SCHAAL	1:20
FORMAAT	A4
STATUS	Definitief
NUMMER	2021-0089
BLAD	22 van 38

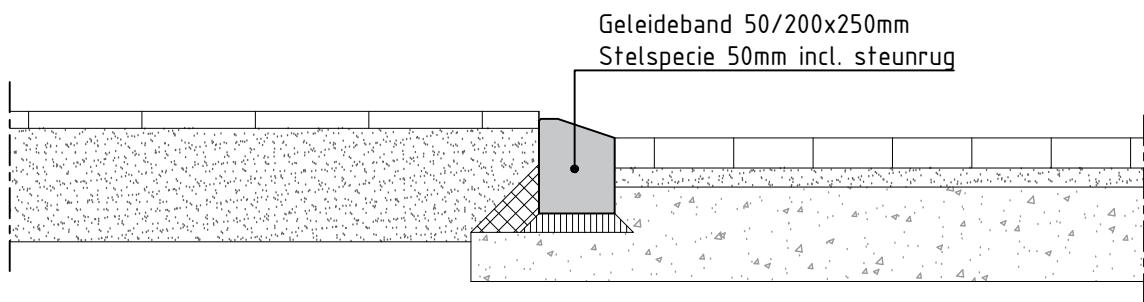

Standaard details

Gemeente Lopik

Detail 23

Geleideband in specie 50/200x250mm

VERSIE	DATUM	GETEKEND	GECONTROLEERD
D.01	07-12-2021	R. Khatri	P. Verweij



**GEMEENTE
LOPIK**

Postbus 50
3410 CB LOPIK

Raadhuisplein 1
Tel: (0348) 55 99 55
Fax: (0348) 55 15 88
E-mailadres:
gemeente@lopik.nl

SCHAAL	1:20
FORMAAT	A4
STATUS	Definitief
NUMMER	2021-0089
BLAD	23 van 38

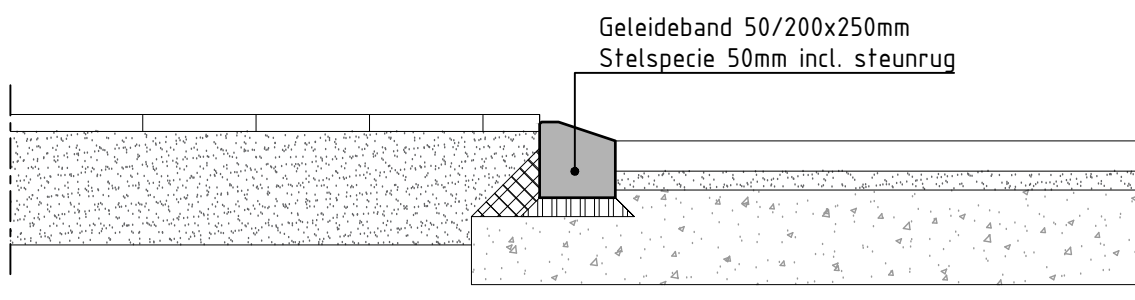

Standaard details

Gemeente Lopik

Detail 24

Geleideband in specie 50/200x200mm

VERSIE	DATUM	GETEKEND	GECONTROLEERD
D.01	07-12-2021	R. Khatri	P. Verweij



Postbus 50
3410 CB LOPIK

Raadhuisplein 1
Tel: (0348) 55 99 55
Fax: (0348) 55 15 88
E-mailadres:
gemeente@lopik.nl

SCHAAL	1:20
FORMAAT	A4
STATUS	Definitief
NUMMER	2021-0089
BLAD	24 van 38

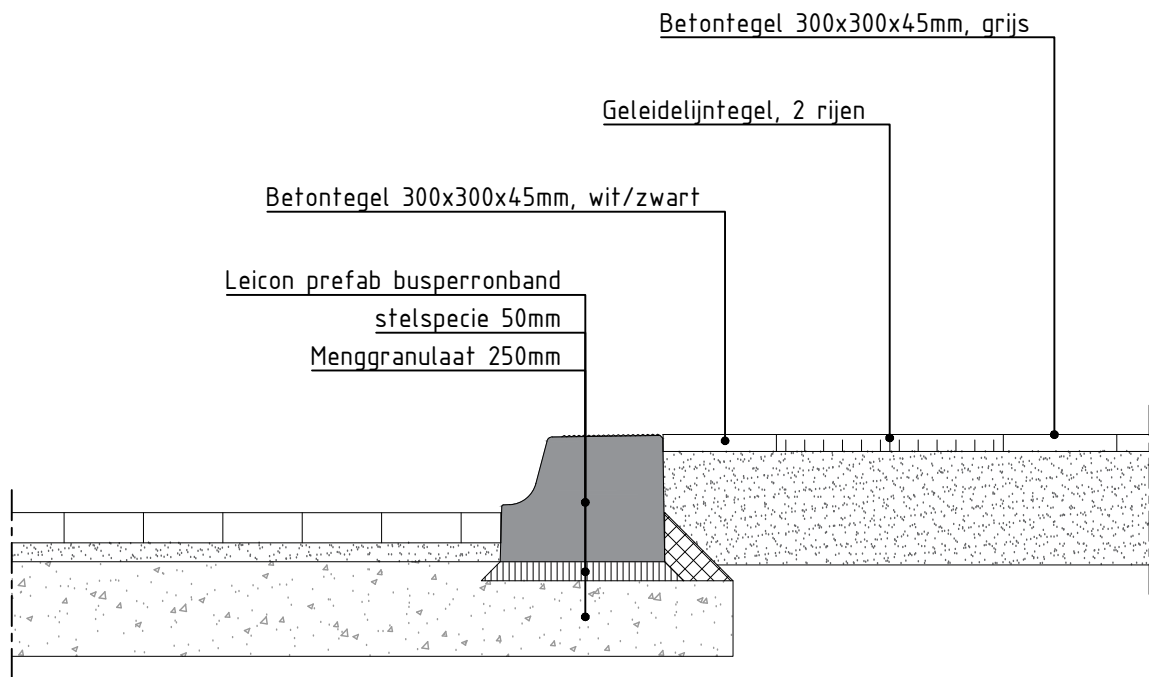

Standaard details

Gemeente Lopik

Detail 25

Leicon prefab busperronband

VERSIE	DATUM	GETEKEND	GECONTROLEERD
D.01	07-12-2021	R. Khatri	P. Verweij



**GEMEENTE
LOPIK**

Postbus 50
3410 CB LOPIK

Raadhuisplein 1
Tel: (0348) 55 99 55
Fax: (0348) 55 15 88
E-mailadres:
gemeente@lopiik.nl

SCHAAL	1:20
FORMAAT	A4
STATUS	Definitief
NUMMER	2021-0089
BLAD	25 van 38

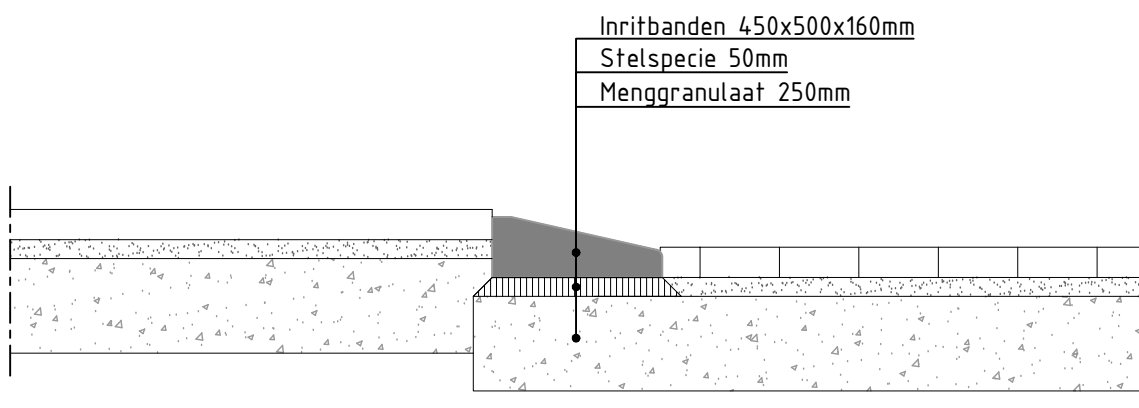

Standaard details

Gemeente Lopik

Detail 26

Inritband in specie 450x500x160mm

VERSIE	DATUM	GETEKEND	GECONTROLEERD
D.01	07-12-2021	R. Khatri	P. Verweij



Postbus 50
3410 CB LOPIK

Raadhuisplein 1
Tel: (0348) 55 99 55
Fax: (0348) 55 15 88
E-mailadres:
gemeente@lopik.nl

SCHAAL	1:20
FORMAAT	A4
STATUS	Definitief
NUMMER	2021-0089
BLAD	26 van 38

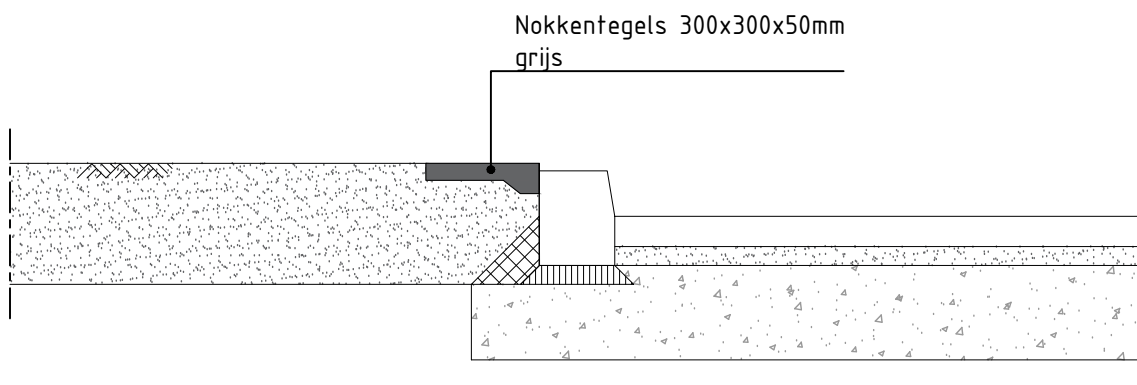

Standaard details
 Gemeente Lopik
 Detail 27
 Nokkentangels 300x300x50mm

VERSIE	DATUM	GETEKEND	GECONTROLEERD
D.01	07-12-2021	R. Khatri	P. Verweij



Postbus 50
 3410 CB LOPIK
 Raadhuisplein 1
 Tel: (0348) 55 99 55
 Fax: (0348) 55 15 88
 E-mailadres:
 gemeente@lopik.nl

SCHAAL	1:20
FORMAAT	A4
STATUS	Definitief
NUMMER	2021-0089
BLAD	27 van 38

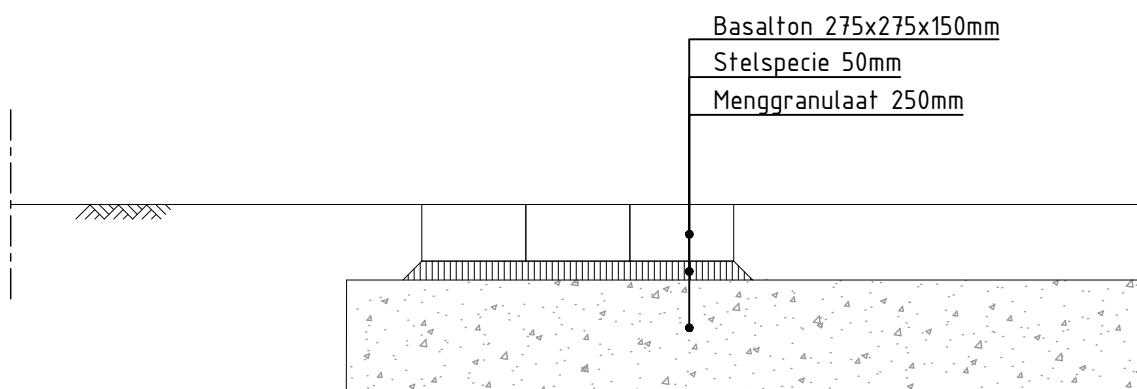

Standaard details

Gemeente Lopik

Detail 28

Rammelstrook basalton 275x275x150mm

VERSIE	DATUM	GETEKEND	GECONTROLEERD
D.01	07-12-2021	R. Khatri	P. Verweij



Postbus 50
3410 CB LOPIK

Raadhuisplein 1
Tel: (0348) 55 99 55
Fax: (0348) 55 15 88
E-mailadres:
gemeente@lopiik.nl

SCHAAL	1:20
FORMAAT	A4
STATUS	Definitief
NUMMER	2021-0089
BLAD	28 van 38

Betonstraatstenen
 Brekerzand 50mm
 Menggranulaat 250mm
 Triaxiaal geogrid, type
 Tensar Triax TX 160 G o.g.
 Zand 350mm

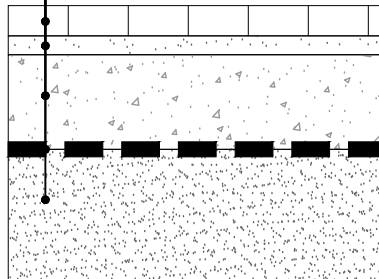

Standaard details
 Gemeente Lopik
 Detail 29
 Opbouw rijbaan en parkeervakken BSS

VERSIE	DATUM	GETEKEND	GECONTROLEERD
D.01	07-12-2021	R. Khatri	P. Verweij



Postbus 50
 3410 CB LOPIK
 Raadhuisplein 1
 Tel: (0348) 55 99 55
 Fax: (0348) 55 15 88
 E-mailadres:
 gemeente@lopiik.nl

SCHAAL	1:20
FORMAAT	A4
STATUS	Definitief
NUMMER	2021-0089
BLAD	29 van 38

Deklaag 40mm, AC 11 surf, DI-B (0% PR)

Tussenlaag 60mm, AC 16 bind, TL-B (max 70% PR)

Onderlaag 60mm, AC 22 base, OL-B (max 70% PR)

Menggranulaat 250mm

Triaxiaal geogrid, type
Tensar Triax TX 160 G o.g.

Zand 350mm

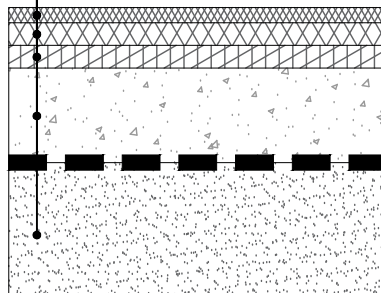

Standaard details

Gemeente Lopik

Detail 30

Opbouw rijbaan en parkeervakken asfalt 1/2

VERSIE	DATUM	GETEKEND	GECONTROLEERD
D.01	07-12-2021	R. Khatri	P. Verweij



Postbus 50
3410 CB LOPIK

Raadhuisplein 1
Tel: (0348) 55 99 55
Fax: (0348) 55 15 88
E-mailadres:
gemeente@lopiik.nl

SCHAAL	1:20
FORMAAT	A4
STATUS	Definitief
NUMMER	2021-0089
BLAD	30 van 38

Deklaag 35mm, AC 11 surf, DI-B (0% PR)
 Tussenlaag 70mm, AC 16 bind, TL-B (max 70% PR)
 Onderlaag 80mm, AC 22 base, OL-B (max 70% PR)
 Menggranulaat 250mm
 Triaxiaal geogrid, type
 Tensar Triax TX 160 G o.g.
 Zand 350mm

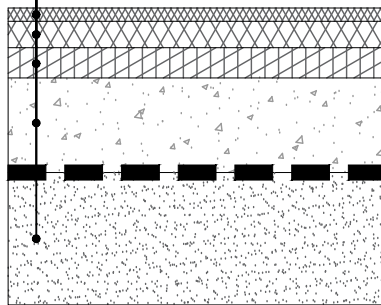

Standaard details

Gemeente Lopik

Detail 31

Opbouw rijbaan en parkeervakken asfalt 2/2

VERSIE	DATUM	GETEKEND	GECONTROLEERD
D.01	07-12-2021	R. Khatri	P. Verweij



Postbus 50
3410 CB LOPIK

Raadhuisplein 1
Tel: (0348) 55 99 55
Fax: (0348) 55 15 88
E-mailadres:
gemeente@lopik.nl

SCHAAL	1:20
FORMAAT	A4
STATUS	Definitief
NUMMER	2021-0089
BLAD	31 van 38

Deklaag 40mm, AC 11 surf, DI-B (0% PR)
 Tussenlaag 60mm, AC 16 bind, TL-B (max 70% PR)
 Onderlaag 60mm, AC 22 base, OL-B (max 70% PR)
 Menggranulaat 250mm
 Triaxiaal geogrid, type
 Tensar Triax TX 160 G o.g.
 Zand 350 mm

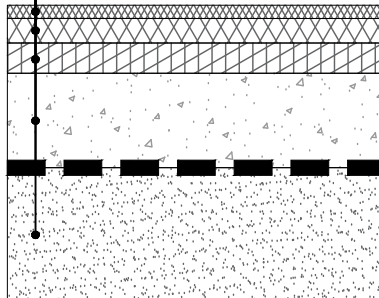

Standaard details

Gemeente Lopik

Detail 32

Opbouw fietspad asfalt t.p.v. oprit

VERSIE	DATUM	GETEKEND	GECONTROLEERD
D.01	07-12-2021	R. Khatri	P. Verweij



Postbus 50
3410 CB LOPIK

Raadhuisplein 1
Tel: (0348) 55 99 55
Fax: (0348) 55 15 88
E-mailadres:
gemeente@lopik.nl

SCHAAL	1:20
FORMAAT	A4
STATUS	Definitief
NUMMER	2021-0089
BLAD	32 van 38

Deklaag 35mm, AC 11 surf, DI-B (0% PR)
 Onderlaag 60mm, AC 22 base, OL-B (max 70% PR)
 Menggranulaat 250mm
 Triaxiaal geogrid, type
 Tensar Triax TX 160 G o.g.
 Zand 350 mm

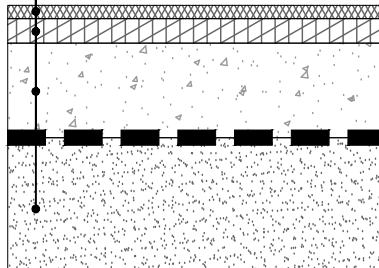

Standaard details
 Gemeente Lopik
 Detail 33
 Opbouw fietspad asfalt

VERSIE	DATUM	GETEKEND	GECONTROLEERD
D.01	07-12-2021	R. Khatri	P. Verweij



Postbus 50
 3410 CB LOPIK
 Raadhuisplein 1
 Tel: (0348) 55 99 55
 Fax: (0348) 55 15 88
 E-mailadres:
 gemeente@lopiik.nl

SCHAAL	1:20
FORMAAT	A4
STATUS	Definitief
NUMMER	2021-0089
BLAD	33 van 38

Betontegels 300x300x80mm

Brekerzand 150mm

Menggranulaat 150mm

Triaxiaal geogrid, type
Tensar Triax TX 160 G o.g.

Zand 350mm

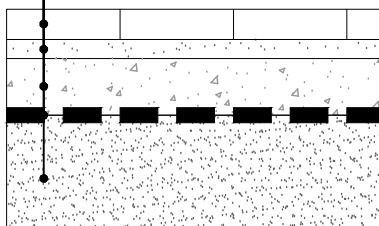

Standaard details

Gemeente Lopik

Detail 34

Opbouw fietspad betontegels

VERSIE	DATUM	GETEKEND	GECONTROLEERD
D.01	07-12-2021	R. Khatri	P. Verweij



Postbus 50
3410 CB LOPIK

Raadhuisplein 1
Tel: (0348) 55 99 55
Fax: (0348) 55 15 88
E-mailadres:
gemeente@lopik.nl

SCHAAL	1:20
FORMAAT	A4
STATUS	Definitief
NUMMER	2021-0089
BLAD	34 van 38

Deklaag 35mm, AC 11 surf, DI-B (0% PR)

Onderlaag 65mm, AC 22 base, OL-B (max 70% PR)

Menggranulaat 250mm

Wegenbouwdoek

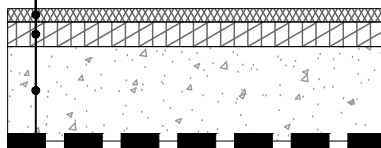

Standaard details

Gemeente Lopik

Detail 35

Opbouw voetpad asfalt

VERSIE	DATUM	GETEKEND	GECONTROLEERD
D.01	07-12-2021	R. Khatri	P. Verweij



**GEMEENTE
LOPIK**

Postbus 50
3410 CB LOPIK

Raadhuisplein 1
Tel: (0348) 55 99 55
Fax: (0348) 55 15 88
E-mailadres:
gemeente@lopik.nl

SCHAAL	1:20
FORMAAT	A4
STATUS	Definitief
NUMMER	2021-0089
BLAD	35 van 38

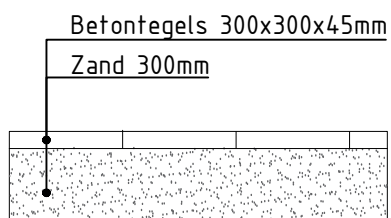

Standaard details
Gemeente Lopik
Detail 36
Opbouw voetpad betontegels

VERSIE	DATUM	GETEKEND	GECONTROLEERD
D.01	07-12-2021	R. Khatri	P. Verweij



Postbus 50
3410 CB LOPIK

Raadhuisplein 1
Tel: (0348) 55 99 55
Fax: (0348) 55 15 88
E-mailadres:
gemeente@lopik.nl

SCHAAL	1:20
FORMAAT	A4
STATUS	Definitief
NUMMER	2021-0089
BLAD	36 van 38

Betontegels 300x300x80mm

Brekerzand 150mm

Menggranulaat 150mm

Wegenbouwdoek

Zand 300mm

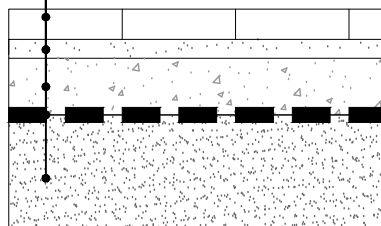

Standaard details

Gemeente Lopik

Detail 37

Opbouw onderhoudspad

VERSIE	DATUM	GETEKEND	GECONTROLEERD
D.01	07-12-2021	R. Khatri	P. Verweij



Postbus 50
3410 CB LOPIK

Raadhuisplein 1
Tel: (0348) 55 99 55
Fax: (0348) 55 15 88
E-mailadres:
gemeente@lopiik.nl

SCHAAL	1:20
FORMAAT	A4
STATUS	Definitief
NUMMER	2021-0089
BLAD	37 van 38

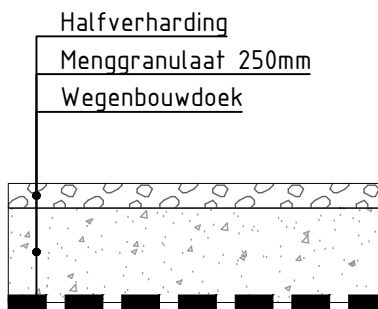

Standaard details
 Gemeente Lopik
 Detail 38
 Opbouw halfverharding

VERSIE	DATUM	GETEKEND	GECONTROLEERD
D.01	07-12-2021	R. Khatri	P. Verweij



Postbus 50
 3410 CB LOPIK
 Raadhuisplein 1
 Tel: (0348) 55 99 55
 Fax: (0348) 55 15 88
 E-mailadres:
 gemeente@lopiik.nl

SCHAAL	1:20
FORMAAT	A4
STATUS	Definitief
NUMMER	2021-0089
BLAD	38 van 38